

front

back

**PHILIPS**

Superslim CL550

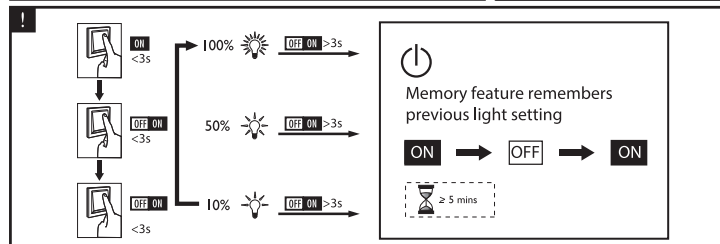
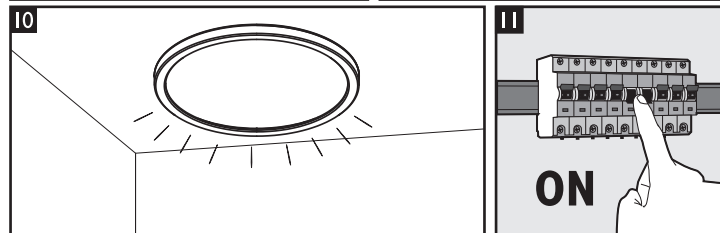
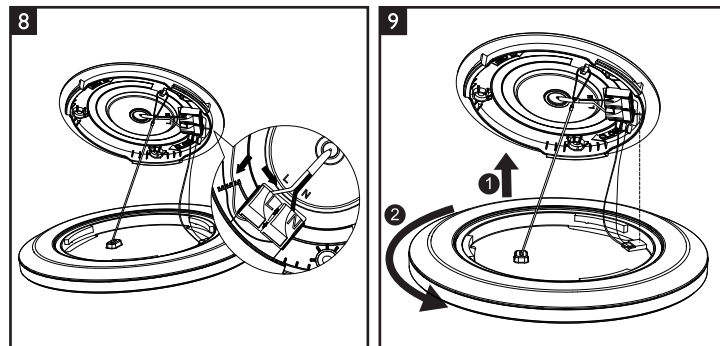
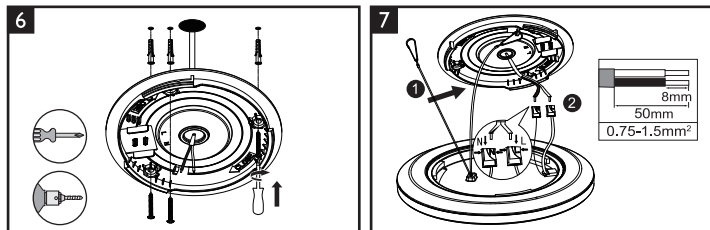
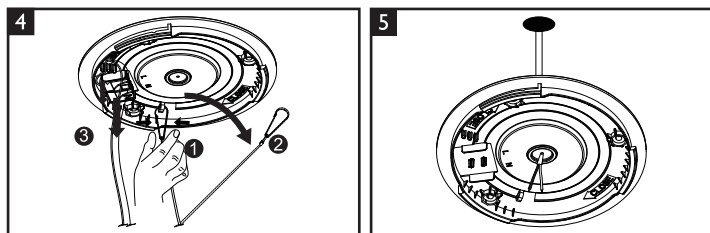
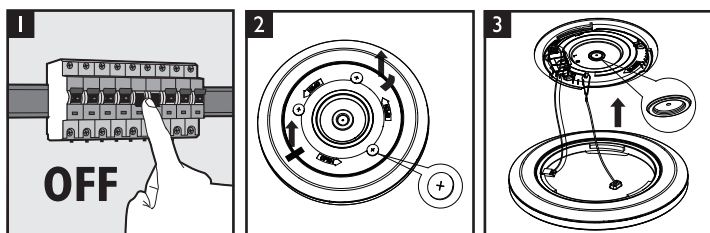
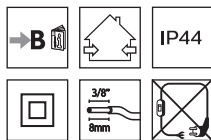

E 9290026674 9290026675 9290026676 9290026678 9290026679

Philips and the Philips shield emblem are registered trademarks of Koninklijke Philips N.V.

Signify  
I.B.R.S. / C.C.R.I. Numéro 10461  
5600 VB Eindhoven, the Netherlands  
www.philips.com/lighting

Signify Commercial UK Limited  
Unit 3, Guildford Business Park,  
Guildford, Surrey, GU2 8XG, UK



3241 657 79702  
Last update: 31/03/21

size: 105mmx148mm